

Alfa Laval SB Anti Vacuum Valve

Safety valves

Introduction

The Alfa Laval SB Anti Vacuum Valve is a compact safety valve that protects tanks from collapse or implosion due to internal vacuum conditions. These conditions occur during emptying, cool-rinsing after hot-cleaning, or caustic cleaning in a CO₂ atmosphere. The compact, easy-to-clean safety valve fits onto any closed process tank, optimizing the personnel safety, reliability and performance of critical processes and maximizing uptime.

Application

This safety valve is designed for use in hygienic processes in the brewery, dairy, food, beverage and many other industries.

Benefits

- Greater process safety
- Low initial cost of investment
- Compact design
- Superior hygiene
- Easy installation

Standard design

The Alfa Laval SB Anti Vacuum Valve is a flange-mounted safety valve. All product wetted steel parts are made of AISI 316L stainless steel with a surface roughness of Ra < 0.8 µm; all other steel parts are made of AISI 304L stainless steel. All product-wetted seals are made of EPDM and all product-wetted polymers are made of PEEK. The valve is PED 2014/68/EU-compliant and available in two versions: either integrated in a SCANDI BREW® tank top system or mounted on its own counter flange.

Working principle

The Alfa Laval SB Anti Vacuum Valve is delivered with a counterweight set and locked for an individual opening vacuum to suit the tank or vessel design pressure. When a vacuum in the tank or vessel is lower than the pre-set opening value, the valve opens and lets in atmospheric air.

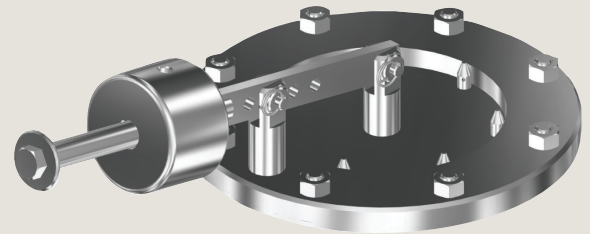

TECHNICAL DATA

Nominalsize	Opening pressure Range (ΔP)	Allowable pressure PS
100 mm	50 - 500 mmH ₂ O	6 bar
150 mm	25 - 500 mmH ₂ O	6 bar
200 mm	25 - 500 mmH ₂ O	6 bar
250 mm	25 - 300 mmH ₂ O	4 bar
300 mm	25 - 500 mmH ₂ O	4 bar
400 mm	25 - 100 mmH ₂ O	4 bar

PHYSICAL DATA

Materials	
Product wetted steel parts:	EN 1.4404 (AISI 316L) with 3.1 cert.
Product wetted steel surfaces:	Surface roughness Ra<0.8 μm
Product wetted seals:	EPDM/NBR
Product wetted polymers:	PEEK
Other steel parts:	EN 1.4307 (AISI 304L)

Cleaning In Place (CIP)

The Anti Vacuum Valve is cleaned, when closed, by the tank cleaning head, but this will not include the valve seating.

To include the valve seating in the cleaning cycle, there are two options:

CIP Kit 1 - Force opener; splash guard

The valve is force-opened during tank CIP. The cleaning of valve seat is dependent on cleaning jets from the tank cleaning head. Any CIP liquid escaping the tank is contained by the splash guard and drains back in to the tank.

CIP Kit 2- Force opener; splash guard; CIP nozzle; CIP closing valve

The valve is force-opened during tank CIP. The cleaning of valve seat is performed by the CIP nozzle. All CIP liquid from the CIP nozzle is contained by the splash guard and drains back in to the tank.



Note! Applying any of above CIP options provides that the tank is pressureless at the moment of force opening the Anti Vacuum Valve

Options

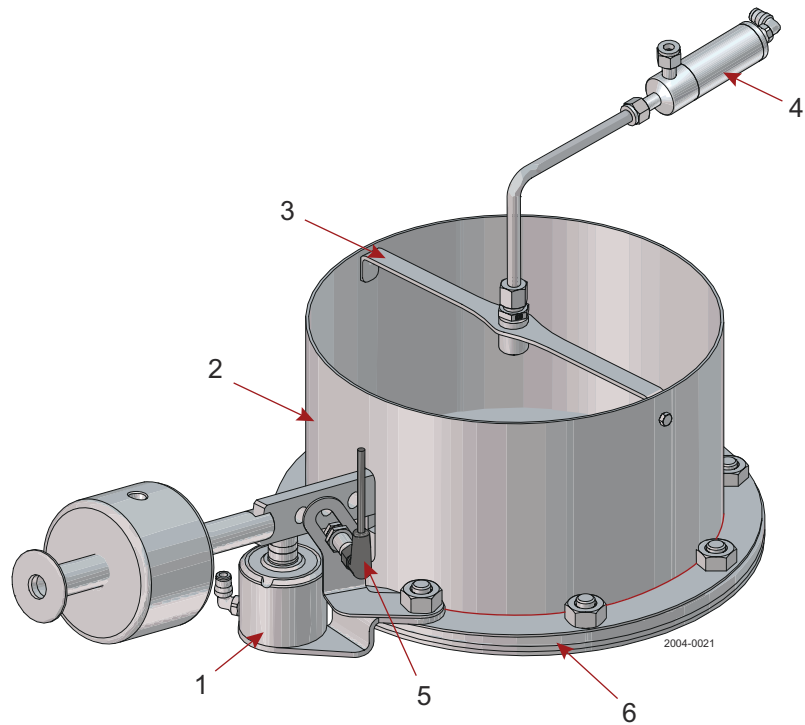

Pos. 1: Force opener: force-opening during valve seat cleaning

Pos. 2: Splash guard: containing CIP liquid during valve seat cleaning

Pos. 3: CIP Nozzle: for cleaning valve seat

Pos. 4: CIP closing valve: applying CIP liquid

Pos. 5: Proximity sensor: for operation detection

Pos. 6: Welding flange: for installation

Heating elements: for valves exposed to sub-zero temperatures

Dimensions (mm)

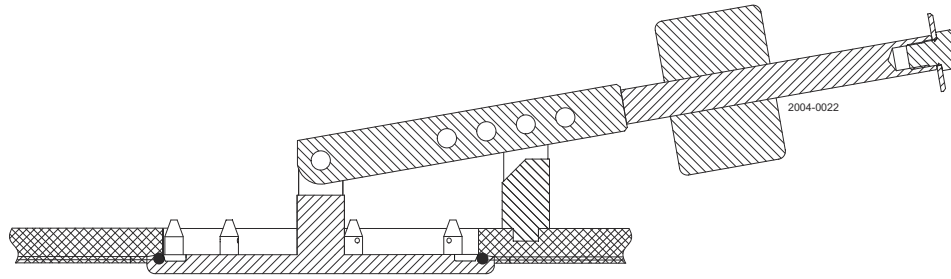

Figure 1. Integrated Valve

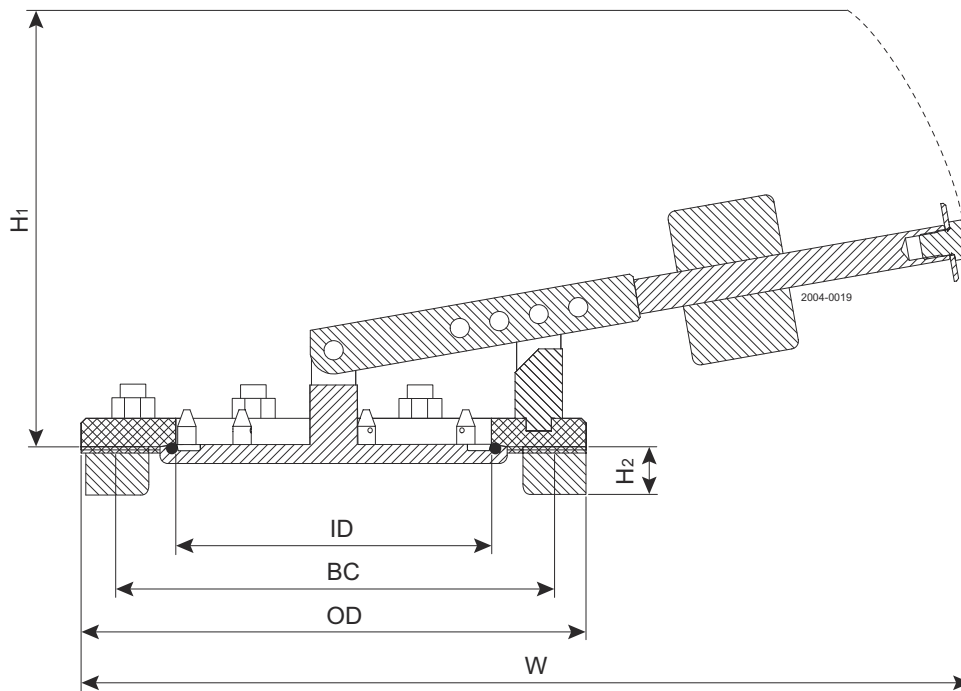

Figure 2. Flange Mounted Valve

ID = Active diameter

BC = Bolt circle

OD = Outside diameter

Interface requirements (mm)

Nominal size	ID	BC	OD	Bolts	H1	H2	W
100	100	165	200	4xM16	310	30	510
150	150	230	270	8xM16	325	30	550
200	200	280	320	8xM16	310	30	570
250	250	330	370	8xM16	325	30	600
300	300	380	420	12xM16	500	30	940
400	400	515	560	12xM16	490	30	1010

Opening pressures

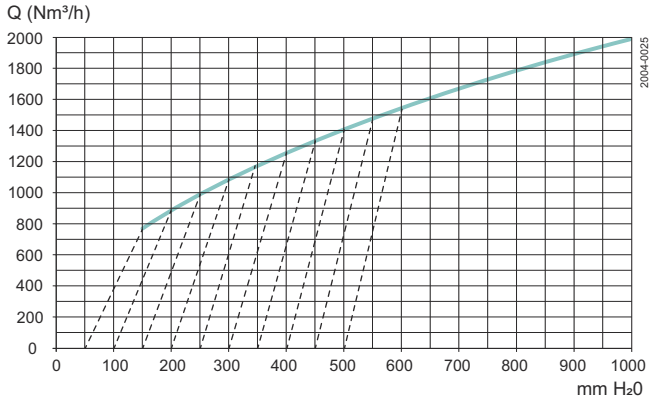

Nominal size : 100mm

Volumetric Flow Capacity

Medium: Air

- - - - Preset opening pressure to fully open valve

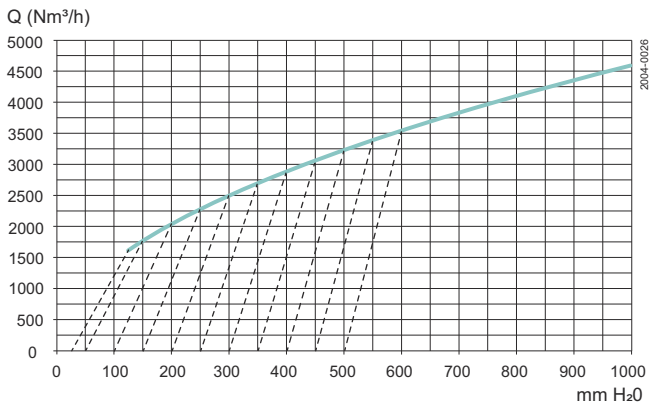

Nominal size : 150mm

Volumetric Flow Capacity

Medium: Air

- - - - Preset opening pressure to fully open valve

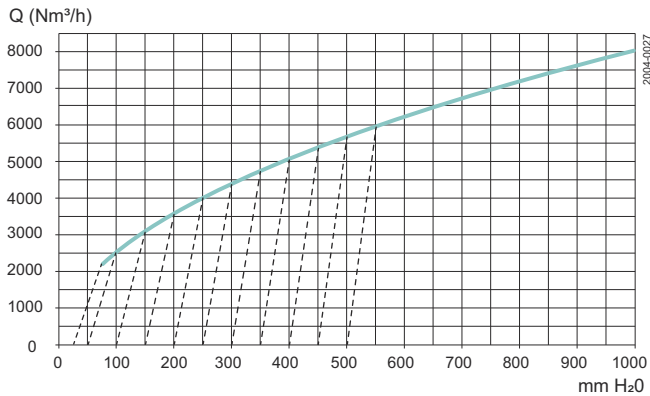

Nominal size : 200mm

Volumetric Flow Capacity

Medium: Air

- - - - Preset opening pressure to fully open valve

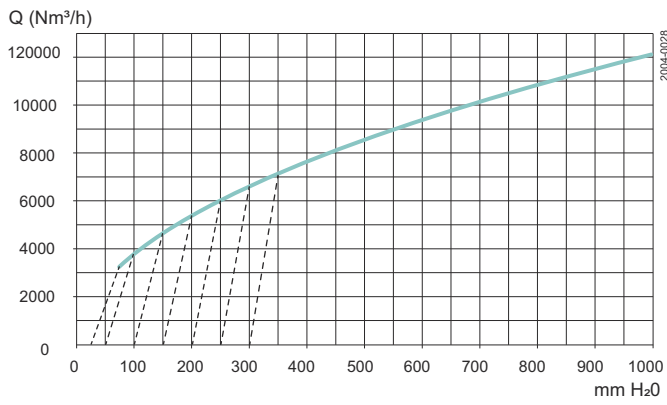

Nominal size : 250mm

Volumetric Flow Capacity

Medium: Air

- - - - Preset opening pressure to fully open valve

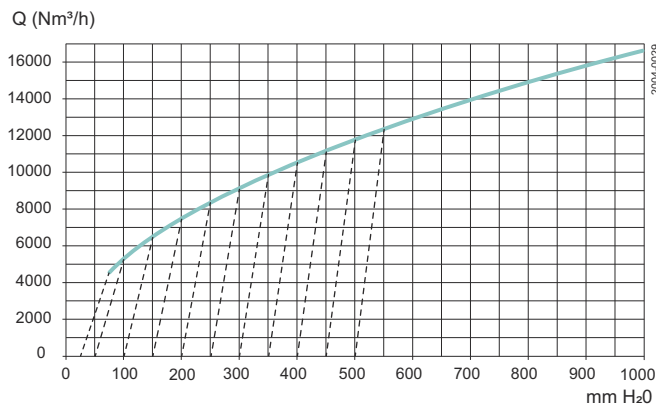

Nominal size : 300mm

Volumetric Flow Capacity

Medium: Air

- - - - Preset opening pressure to fully open valve

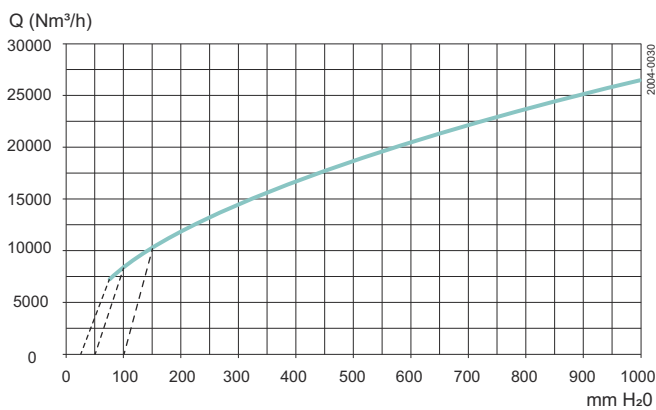

Nominal size : 400mm

Volumetric Flow Capacity

Medium: Air

- - - - Preset opening pressure to fully open valve

This document and its contents are subject to copyrights and other intellectual property rights owned by Alfa Laval Corporate AB. No part of this document may be copied, re-produced or transmitted in any form or by any means, or for any purpose, without Alfa Laval Corporate AB's prior express written permission. Information and services provided in this document are made as a benefit and service to the user, and no representations or warranties are made about the accuracy or suitability of this information and these services for any purpose. All rights are reserved.

200003952-1-EN-GB

© Alfa Laval Corporate AB

How to contact Alfa Laval

Up-to-date Alfa Laval contact details for all countries are always available on our website at www.alfalaval.com